



INSTALLATION MANUAL

Solar PV Module



Saatvik Green Energy (P) Ltd.

Doc No: SGE/NPD/IM
Rev No/Date: 00/04.10.2022

Contents

1.0 Overview.....	2
1.1 Warnings	2
2.0 Module Unloading	4
2.1 Container Loading.....	4
2.1.1 Crane unloading.....	4
2.1.2. Forklift unloading.....	4
.....	6
2.2 Storage Location Guidelines	6
2.3 Module Unboxing instruction.....	7
2.3.1 Method A (Gen 01 Design).....	7
2.3.2 Method B (Gen 02 Design).....	7
3.0 Installation.....	8
3.1 Installation Safety.....	8
3.2 Installation Condition.....	10
3.2.1 Climate conditions.....	10
3.2.2 Site Selection.....	10
3.2.3 Tilted Angle Section:	11
3.3 Mechanical Installation Guidelines.....	12
3.3.1 Mounting with Bolts.....	12
3.3.2 Mounting with Clamps	13
.....	13
3.3.3 Mechanical drawing PV Modules.....	13
3.3.4 Technical Specification of Modules.....	17
3.3.5 Recommendation Mounting Method	18
4.0 Electrical Installation.....	21
Series Wiring.....	21
.....	21
Parallel wiring.....	21
5.0 Grounding	23
6. Important Instruction for Installation:	24
7.0 Module Cleaning	25
7.1 Method A: Compressed Water.....	26
7.2 Method B: Compressed Air.....	26
7.3 Method C: Wet Cleaning.....	26
7.4 Method D: Robot Cleaning	26
8.0 Release and Execution.....	27
9.0 Contact Details.....	27
Plant Address.....	27
Corporate Address.....	27
Email.....	27
Phone	27

1.0 Overview

This guide contains information regarding the installation and safe handling of Saatvik Green energy (P) Ltd 's photovoltaic module (hereinafter referred to as "module"). Saatvik green Energy (P) Ltd referred to as "Saatvik Solar".

Installers must read and understand this guide prior to installation. For any questions, please contact Saatvik Team & Customer Support department or our local representatives for more detailed information. Installers must follow all safety precautions as described in this guide as well as local requirement and regulations by law or authorized organizations.

Before installing a solar photovoltaic system, installers should familiarize themselves with its mechanical and electrical requirements. Keep this guide in a safe place for future reference (care and maintenance) and in case of sale or disposal of the modules.

Saatvik modules are tested and certified for installation worldwide. Different regions may have different regulations for solar PV installations. In this guide, hereinafter "IEC Only" is used to refer to regions where IEC standard applies, e.g. Europe, Middle East, most of Asia Pacific countries; "UL Only" is used to refer to regions where UL standard applies, e.g. United States, Canada; all other references are global.



1.1 Warnings:

- PV modules generate DC electrical energy when exposed to sunlight or other light sources. Active parts of module such as terminals can result in burns, sparks, and lethal shock.
- Artificially concentrated sunlight shall not be directed on the module or panel.
- Front protective glass is utilized on the module. Broken solar module glass is an electrical safety hazard (may cause electric shock or fire). These modules cannot be repaired and should be replaced immediately.
- To reduce the risk of electrical shocks or burns, modules may be covered with an opaque material during installation to avoid injury.
- The installation work of the PV array can only be done under the protection of sun-sheltering covers or sunshades and only qualified person can install or perform maintenance work on this module.
- Follow the battery manufacture's recommendations if batteries are used with modules.
- Do not use this module to replace or partly replace roofs and walls of living buildings.
- Do not install modules where flammable gas may be present.
- Do not remove any part installed by Saatvik Solar or disassemble the module.
- All instructions should be read and understood before attempting to install, wire, operate and maintain the module.
- All PV systems must be grounded to earth. If there is no special regulation, please follow the National Electrical Code or other national code
- Under normal conditions, a photovoltaic module is likely to experience conditions that produce more current and/or voltage than reported at standard test conditions. Accordingly, the value of I_{sc} and V_{oc} marked on the module should be multiplied by 1.25 when determining PV system component voltage ratings, conductor current ratings, fuse sizes, and size of controls connected to the PV output.
- Once the PV module has been shipped to the installation site, all of the parts should be unpacked properly with care.
- Do not stand or step on the PV module like below pictures show. This is prohibited and there is a risk of damage to the module and cause injury for you.

- Only PV modules with the same cell size should be connected in series.
- During transporting modules, please attempt to minimize shock or vibration to the module, as this may damage the module or lead to cell micro cracks.
- During all transportation situations, never drop the module from a vehicle, house or hands. This will damage module.
- Modules (glass, junction boxes, connectors, etc.) shall be protected from long-term exposure to environments containing sulphur, strong acid, strong alkaline, etc., which may pose a risk of corrosion to the product.
- Do not clean the glass with chemicals. Only use tap water. Make sure the module surface temperature is cool to the touch. Cleaning modules with cool water when module surface temp is high may result in glass breakage. Do not brush paint or corrosive substances on the surface of the modules.
- Do not disconnect any of the modules when under load. If you need to disconnect the connector, you must first close the DC and AC converter or disconnect junction box master switch
- When looking at PV modules with anti-reflection (AR) coating technology, it will be normal to see some cells with a slight colour difference at different angles.
- The junction box connector should not be in contact with oily substances, organic solvents and other corrosive materials to avoid damage to the connector. For example, alcohol, gasoline, lubricants, rust inhibitors, herbicides and so on. If the connector is polluted, need to replace new connector to use again.
- Before the installation of modules, it is recommended to add rainproof facilities in the project site to avoid direct open-air placement
- The maximum altitude the PV module is designed for $\leq 2000\text{m}$
- The maximum irradiance is $1300\text{W}/\text{m}^2$ for module with transparent rear

Meaning of crossed –out wheeled dustbin:



- Do not dispose of electrical appliances as unsorted municipal waste, use separate collection facilities.
- Contact your local government for information regarding the collection systems available.
- If electrical appliances are disposed of in landfills or dumps, hazardous substances can leak into the groundwater and get into the food chain, damaging your health and well-being.
- When replacing old appliances with new ones, the retailer is legally obligated to take back your old appliance for disposals at least free of charge.

2.0 Module Unloading

Upon arrival of the modules, please check the packaging box is in good condition, and check whether the module type and quantity on the outer packaging are consistent with the delivery order, if anything is wrong, please contact Saatvik Solar logistics and sales staff immediately

2.1 Container Loading

2.1.1 Crane unloading

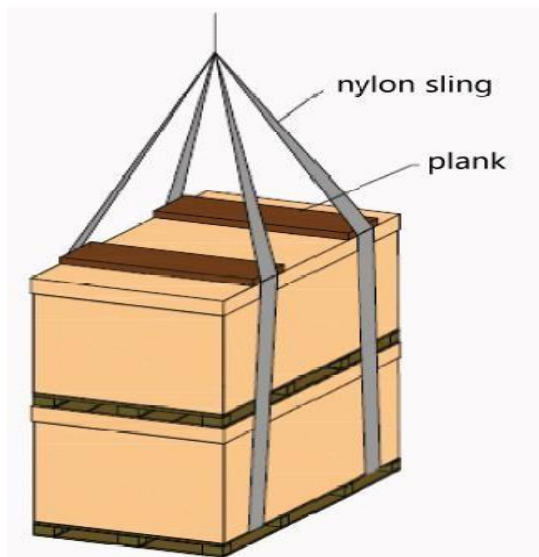

Note: Without Plank Crane unloading not allowed

When crane is used to unload the modules, please choose and use specialized tooling according to the weight and size of the module. Please adjust the position of the sling to keep the modules steady. To ensure the safety of the module, wooden sticks, boards or other fixtures of the same width as the outer packing cases should be used on the upper part of the box to prevent the sling from squeezing the pallet and damaging the modules. When placing the modules, do not lower the packing box too quickly and put it on a flat ground.

For vertically landscape packages, do not lift up more than TWO pallets of modules at once; for vertically portrait packages, do not lift up more than ONE pallet of modules at once. Do not unload modules under the weather conditions of wind more than 6 class (in Beaufort scale), heavy rain or heavy snow.



2.1.2. Forklift unloading

- Please choose a suitable forklift according to weight.

- The fork should go into the pallet at least 3/4 of the pallet depth during unloading.
- Drive slowly and do not allow forks to hit the cartons or pallets.



- It is recommended to operate the forklift from the Aluminium frame side of the module and not touch the glass side. If the operation must be carried out on the glass side, please place buffer protection material in advance to prevent the inside modules being damaged due to the external force.
- It is recommended to extend the height or width of the forklift backrest so that the force is distributed on the modules' aluminium frame.

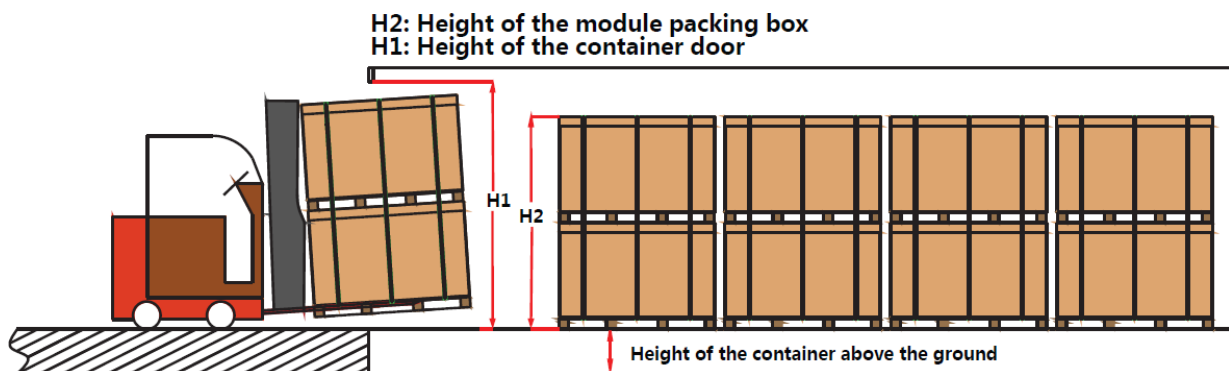

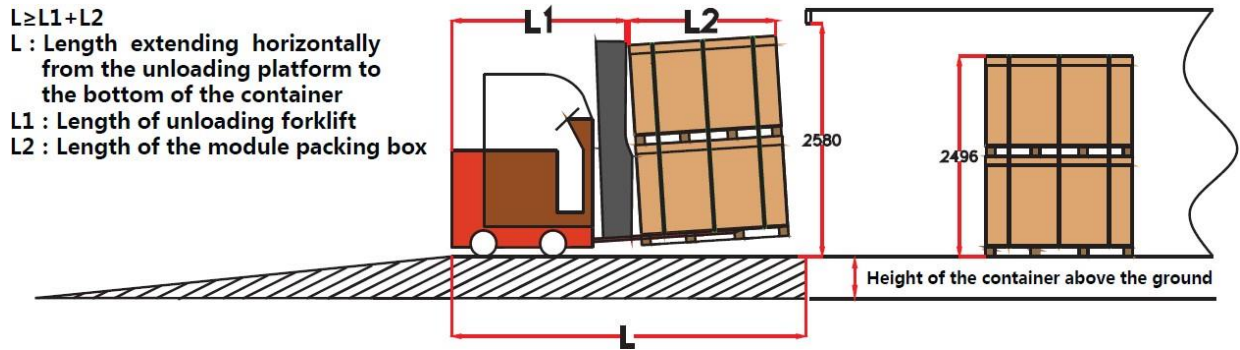

2.2 Storage Location Guidelines

- Don't Store Pallets on Uneven surface



- Don't remove the original package and keep the wrapping film and carton box in a good condition, if the modules require long-distance transport or long-term storage.
- In rainy weather, please fully cover the modules and pallets with a rain protection and take moisture-proof measures on pallets and cartons to prevent collapse and moisture ingress.



- Don't allow unauthorized persons to access the module storage area.
- Don't leave modules unsupported or unsecured.
- Don't stack modules on the project site.

2.3 Module Unboxing instruction

2.3.1 Method A (Gen 01 Design)

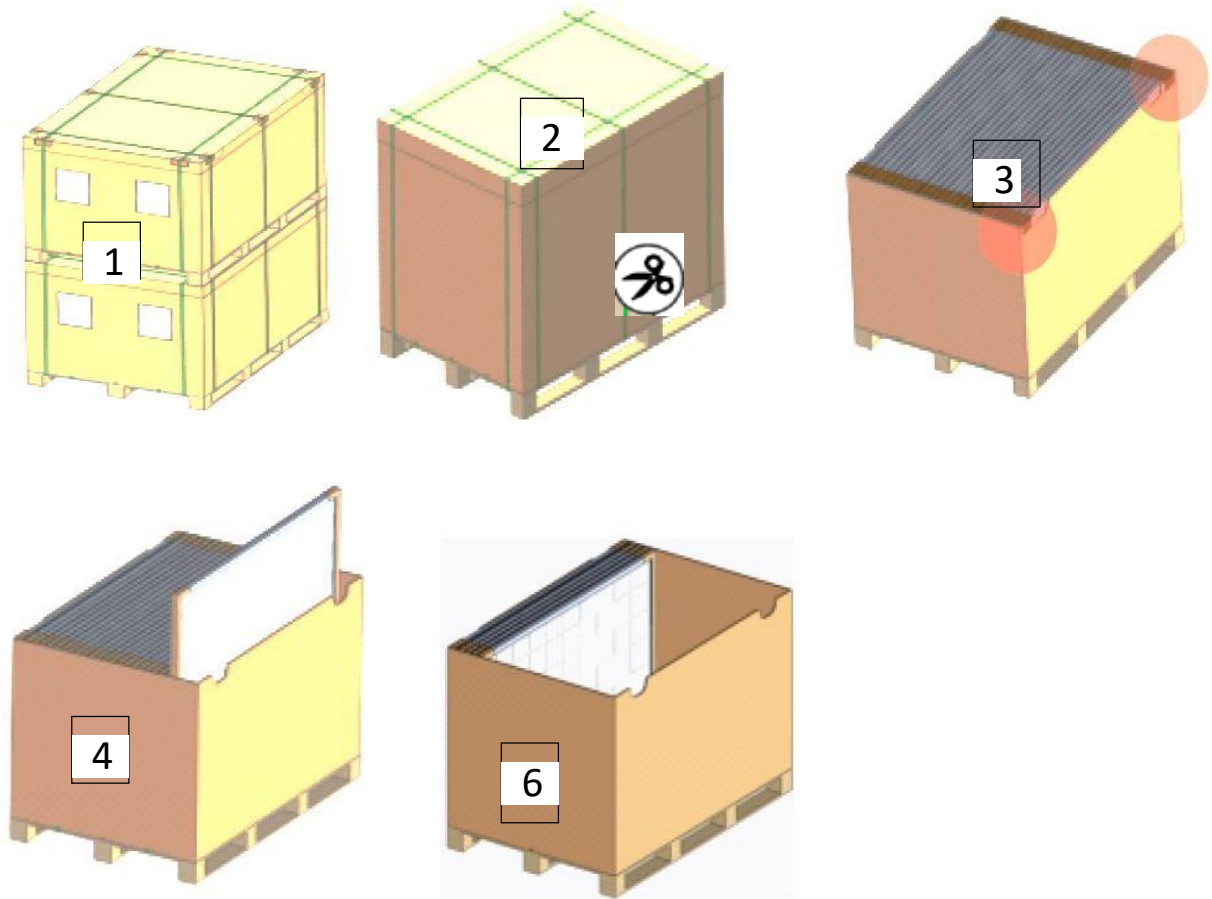

2.3.2 Method B (Gen 02 Design)

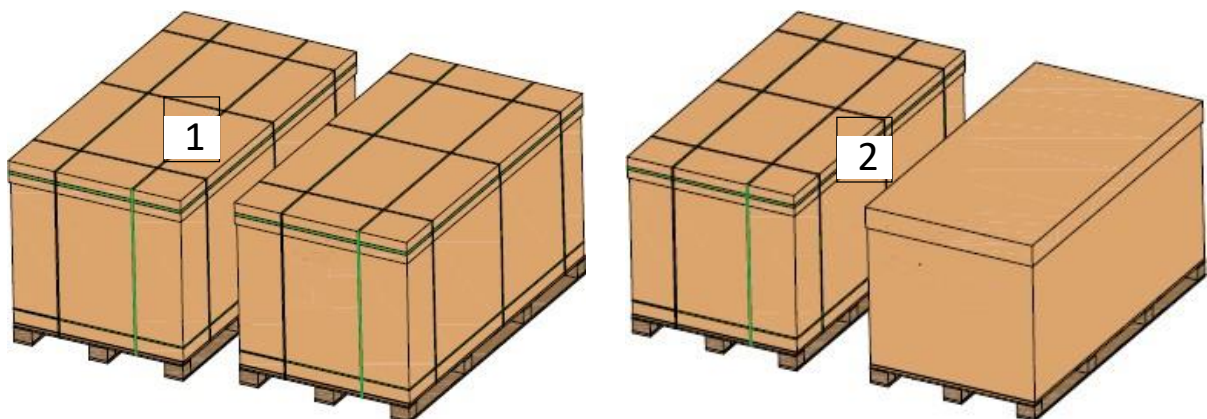

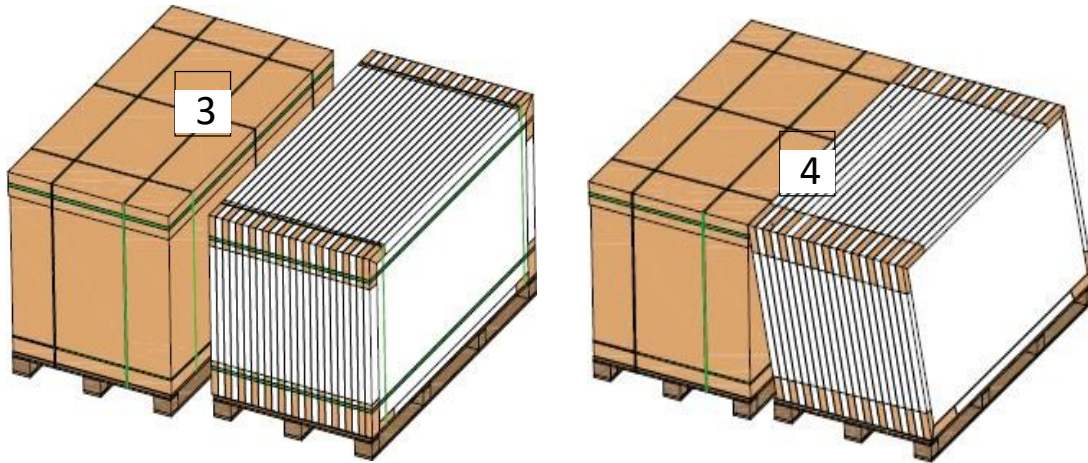

3.0 Installation

3.1 Installation Safety:

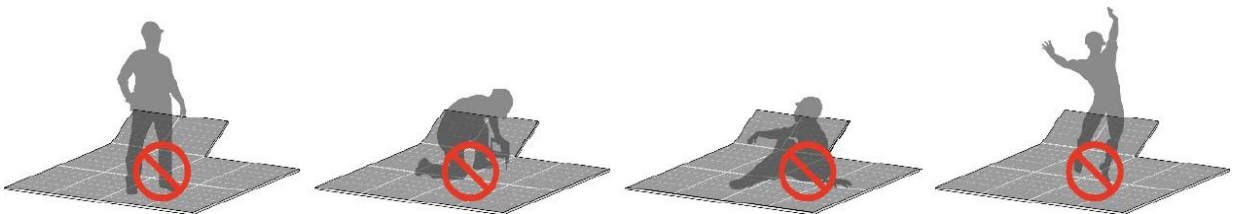

- Always wear protective head gear, insulating gloves and safety shoes (with rubber soles) and other protective measures during installation.

- When installing or maintaining the photovoltaic system, please do not wear metal rings, watches and other metal products, so as not to cause electric shock danger and damage the modules.
- Keep the PV module packed in the carton until installation. Once the modules are removed from the packing box, they should be installed and connected to the bus box in time. If they are not installed immediately, protective measures (such as adding rubber joint cover, etc.) should be taken on the connection head
- Do not touch the PV module unnecessarily during installation. The glass surface and the frame may be hot. There is a risk of burns and electric shock
- Do not work in rain, snow or windy conditions
- Due to the risk of electrical shock, do not perform any work if the terminals of the PV module are wet
- Use insulated tools and do not use wet tools
- When installing PV modules, do not drop any objects (e.g., PV modules or tools).
- Make sure flammable gasses are not generated or present near the installation site.
- Insert module connectors fully and correctly. An audible "click" sound should be heard. This sounds confirms the connectors are fully seated. Check all connections
- Connect the male and female connectors correctly, check the wiring condition, all wires shall not be separated from the modules, and secure the wires with cable ties so that the wires do not scratch or squeeze the back sheet of the modules.

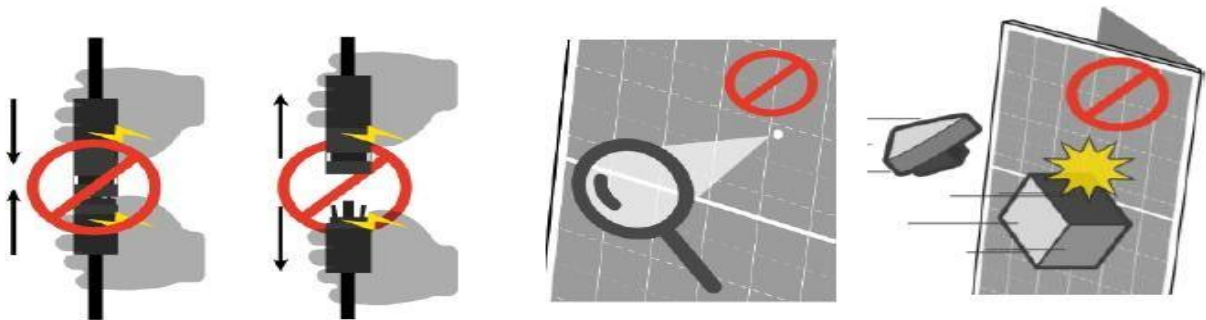

- Do not touch the junction box and the end of the interconnect cables (connectors) with bare hands during installation or under sunlight, regardless if the PV module is connected to or disconnected from the system.
- The junction box must be protected from direct sunlight and water. The connector must meet the IP68 water-tight standard after being connected. However, it is not recommended to use the connector under water for a long time
- Do not expose the PV module to excessive loads on the surface of the PV module or twist the frame.
- Do not hit or put excessive load on the glass or back sheet, this may break the cells or cause micro cracks.
- During the installation or operation, don't use sharp tools to wipe the back sheet and glass. Scratches can appear on the module.
- Do not drill holes in the frame. It may cause corrosion of the frame.

- When installing modules on roof mounted structures, please try to follow the “from top to bottom” and/or “from left to right” principle, and don’t step on the module. This will damage the module and would be dangerous for personal safety.
- Modules will have thermal expansion and cold contraction effect. When installing, the interval between two adjacent conventional modules is recommended > 10mm. If there are special requirements subject to Saatvik approvals.

3.2 Installation Condition



3.2.1 Climate conditions:

- Operating temperature: within -40°C (-40°F) to 85°C (185°F)
- Humidity: < 85RH%

Note: The mechanical load bearing (include wind and snow loads) of the module is based on the approved mounting methods. The professional system installer must be responsible for mechanical load calculation according to the system design.

3.2.2 Site Selection



- In most applications, Saatvik solar PV modules should be installed in a location where they will receive maximum sunlight throughout the year. In the Northern Hemisphere, the module should typically face south, and in the Southern Hemisphere, the modules should typically face north.
- Modules facing 30 degrees away from true South (or North) will lose approximately 10 to 15 percent of their power output. If the module faces 60 degrees away from true South (or North), the power loss will be 20 to 30 percent.
- When choosing a site, avoid trees, buildings or obstructions, which could cast shadows on the solar photovoltaic modules especially during the winter months when the arc of the sun is

lowest over the horizon. Shading causes loss of output, even though the factory fitted bypass diodes of the PV module will minimize any such loss.

- Do not install the PV module near open flame or flammable materials.
- When solar modules are used to charge batteries, the battery must be installed in a manner, which will protect the performance of the system and the safety of its users. Follow the battery manufacturer's guidelines concerning installation, operation and maintenance recommendations. In general, the battery (or battery bank) should be away from the main flow of people and animal traffic. Select a battery site that is protected from sunlight, rain, snow, debris, and is well ventilated. Most batteries generate hydrogen gas when charging, which can be explosive. Do not light matches or create sparks near the battery bank.
- When a battery is installed outdoors, it should be placed in an insulated and ventilated battery case specifically designed for the purpose.
- Do not install the PV module in a location where it would be immersed in water or continually exposed to water from a sprinkler or fountain etc.
- The PV module can be installed at a distance of 50 m to 500m from the seashore. However, when installing module in offshore areas, protect the connectors or add dust plugs. After removing the dust plugs, connect the connectors immediately and take other anti-rust measures to prevent rust.

3.2.3 Tilted Angle Section:

- The tilt angle of the PV module is measured between the surface of the PV module and a horizontal ground surface. The PV module generates maximum output power when it faces the sun directly

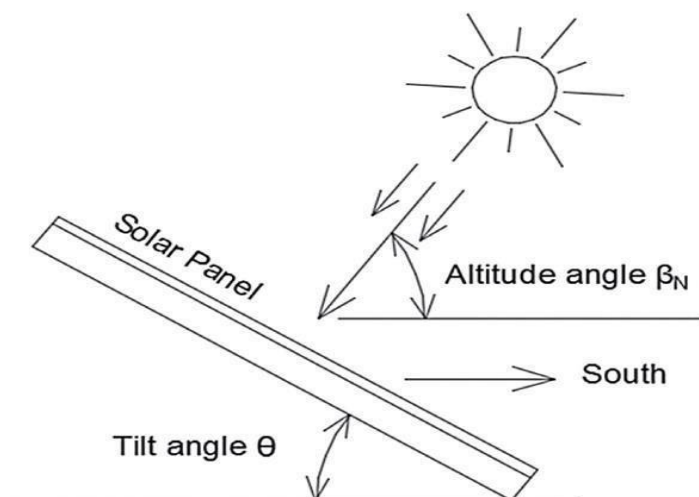

- For standalone systems with batteries where the PV modules are attached to a permanent structure, the tilt angle of the PV modules should be selected to optimize the performance based on seasonal load and sunlight. In general, if the PV output is adequate when irradiance is low (e.g., winter), then the angle chosen should be adequate during the rest of the year. For grid-connected installations where the PV modules are attached to a permanent structure, PV

modules should be tilted so that the energy production from the PV modules will be maximized on an annual basis.

3.3 Mechanical Installation Guidelines

Solar PV modules usually can be mounted by using the following methods: bolts and clamps.

• **Note:**

- 1) All installation methods herein are only for reference, and Saatvik solar will not provide related mounting components, the system installer or trained professional personnel must be responsible for the PV system's design, installation, and mechanical load calculation and security of the system.
- 2) Before installation, the following items should be addressed:
 - A. Visually check the module for any damage. Clean the module if any dirt or residue remains from shipping.
 - B. Check if module serial number stickers match.

Identification serial Number:

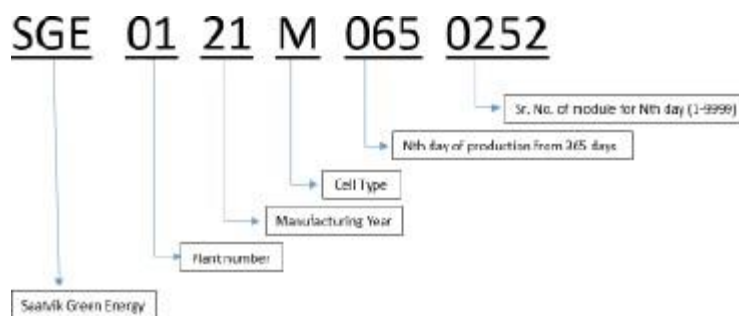

Note: The above Sr. no. indicates that the modules has been manufactured on 65th Day of the 2021 year and the module counting is 0252 number of 65th Day.

- 3) Saatvik modules are designed to meet a maximum positive (or downward) pressure of 3600Pa (Only refer to the mentioned module type in this manual) and negative (or upward) pressure of 1600Pa. This design load was then tested with a safety factor of 1.5 times. So Saatvik's modules are tested under a maximum downward pressure of 5400Pa and upward pressure of 2400Pa. When mounting modules in snow-prone or high-wind environments, special care should be taken to mount the modules in a manner that provides sufficient design strength while meeting local code requirements.

3.3.1 Mounting with Bolts



The frame of each module has 8 mounting holes (Length* Width: 14mm*9mm) used to secure the modules to support structure. Always use all the eight mounting holes to secure the modules. The module frame must be attached to a mounting rail using M8 corrosion-proof bolts together with spring washers and flat washers in eight symmetrical locations on the PV module. The applied torque value should be big enough to fix the modules steadily.

The reference value for M8 bolt is 16~20N*m. As to special support system or special installation requirement, please reconfirm with the support's supplier for the torque value. Please find detailed mounting information in the below illustration as Figure

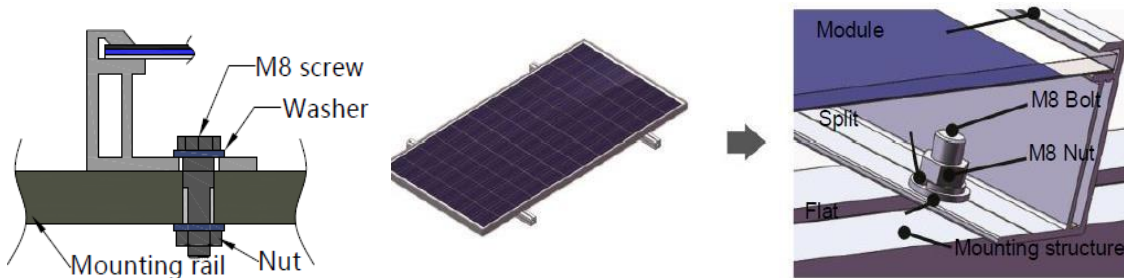

3.3.2 Mounting with Clamps



**** The required length for each clamp is minimum 50 mm, and wall thickness of its upper part is no less than 5mm**

Note : The modules must be properly secured to their support so that they can withstand live load conditions, including positive and negative load, to the pressure they have been certified for. It is the installer's responsibility to ensure that the clamps used to secure the modules are strong enough and modules Mechanical Drawing details given in Section 2.3.3

3.3.3 Mechanical drawing PV Modules:



- **Model No : SGE XXX-156MHC - 560-590 Wp**

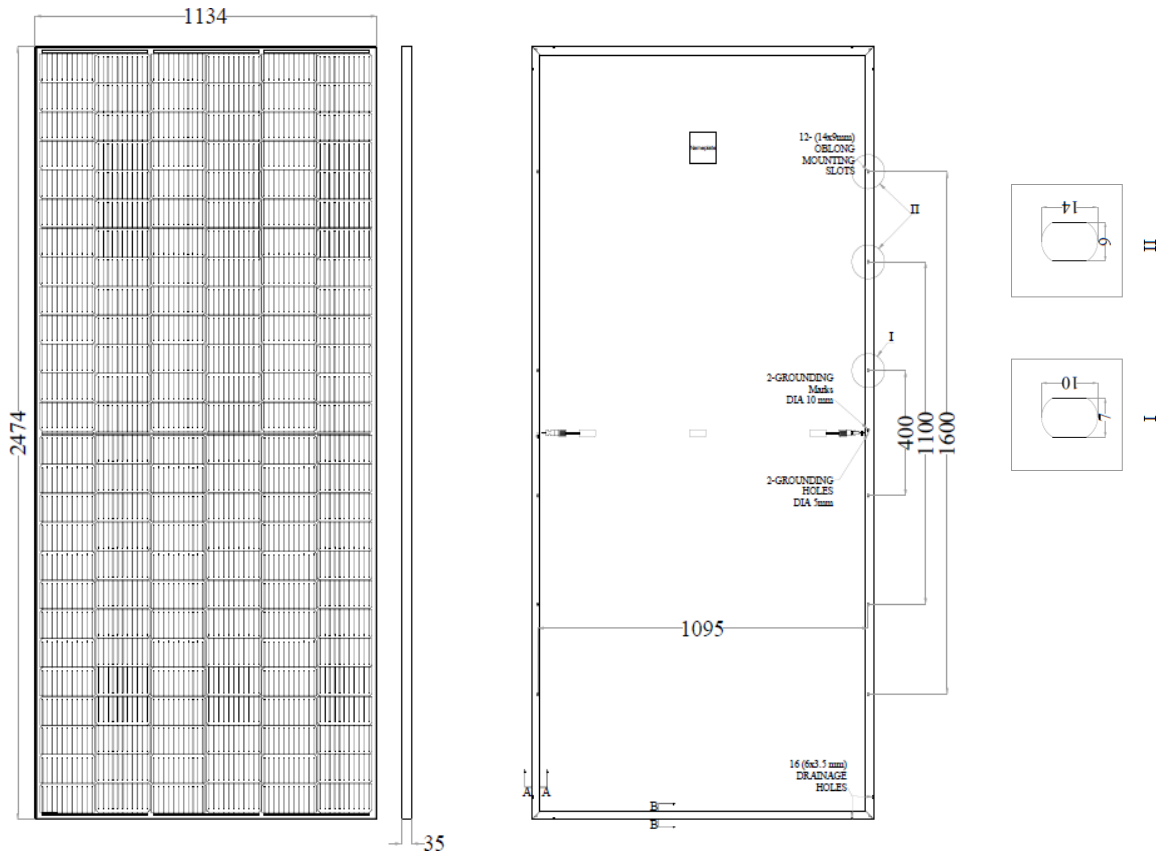

- **Model No : SGE XXX-144MHC- (520-550 Wp)**

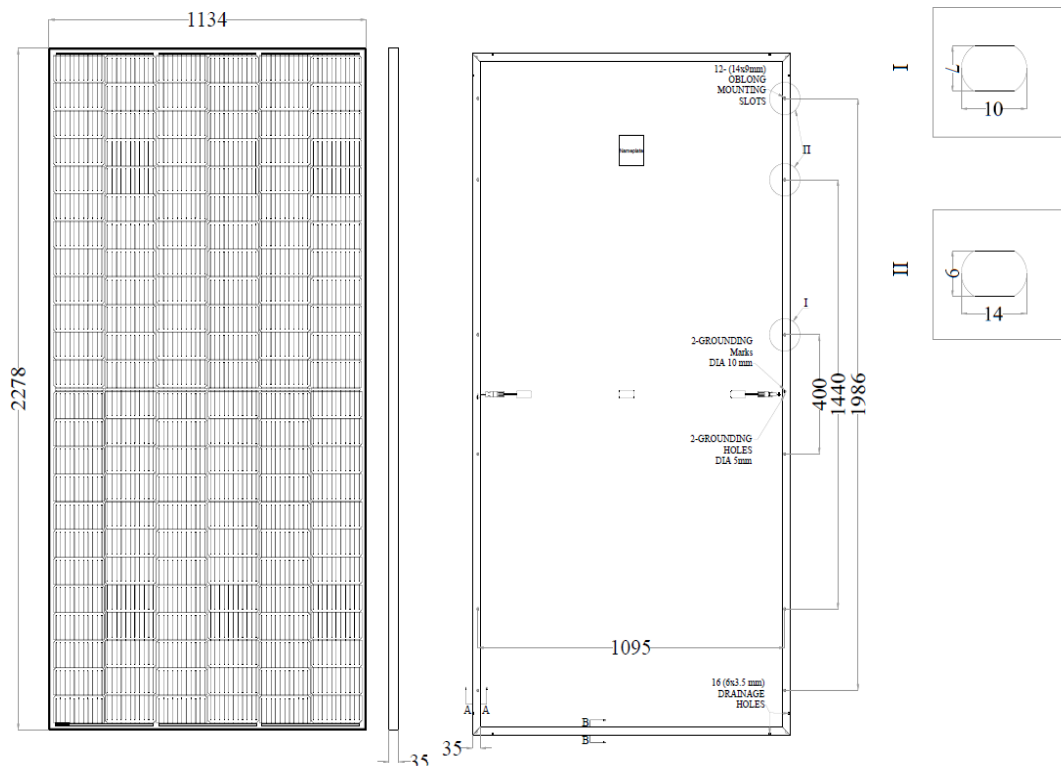

- Model No : SGEXXX-132MHC(470-505) Wp

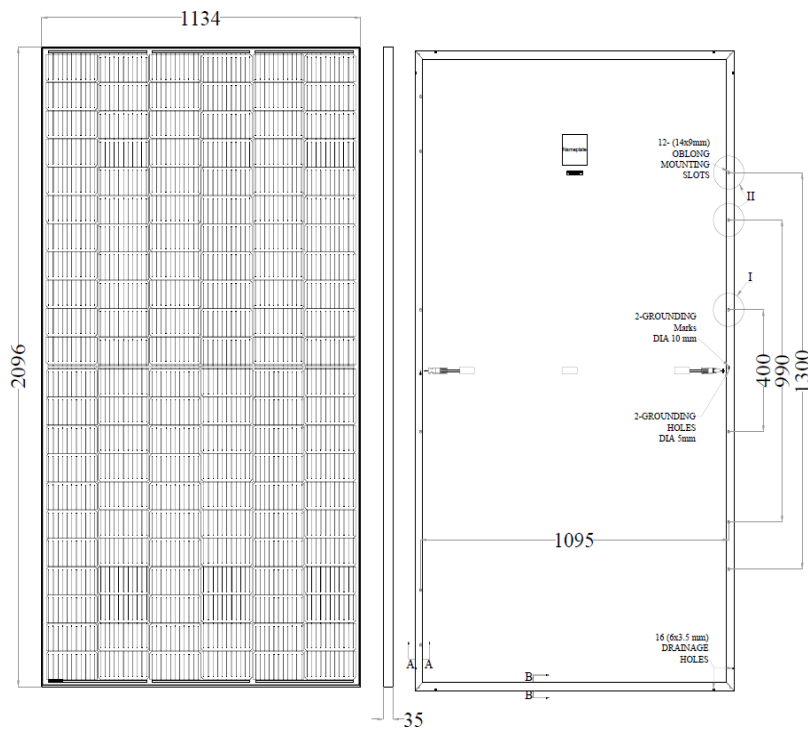

- Model No : SGEXXX-120MHC (420-460 Wp)

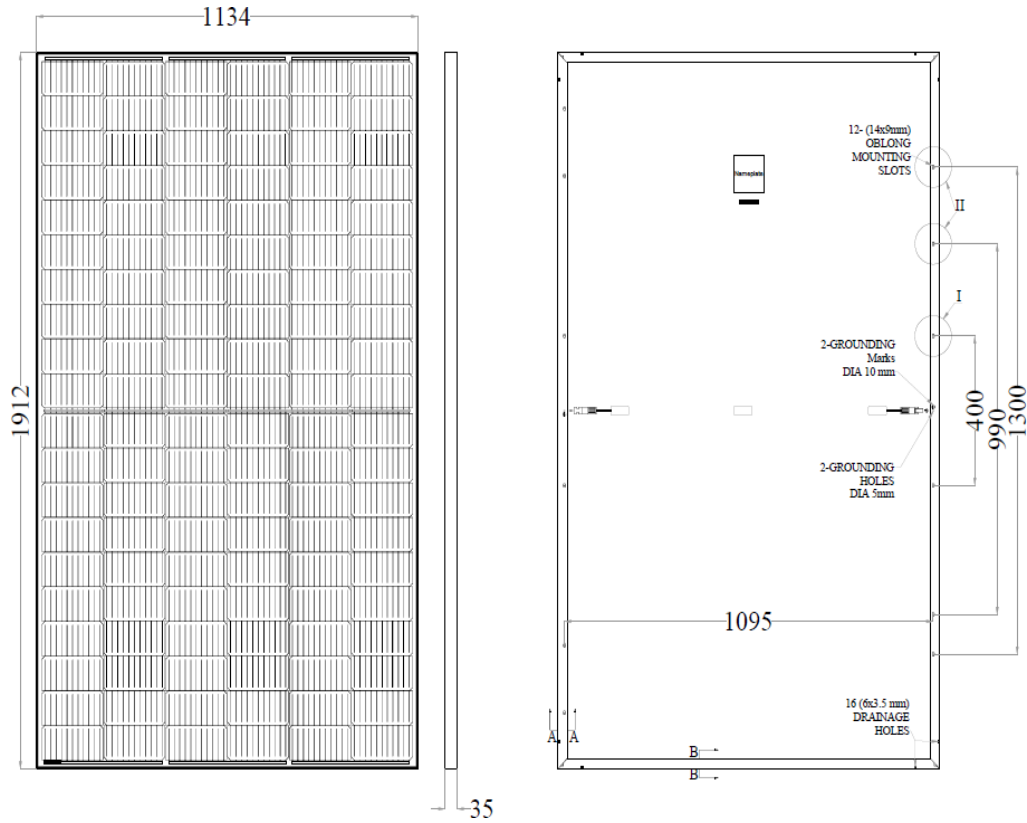

- **Model No : SGEXXX-108MHC (370-415 Wp)**

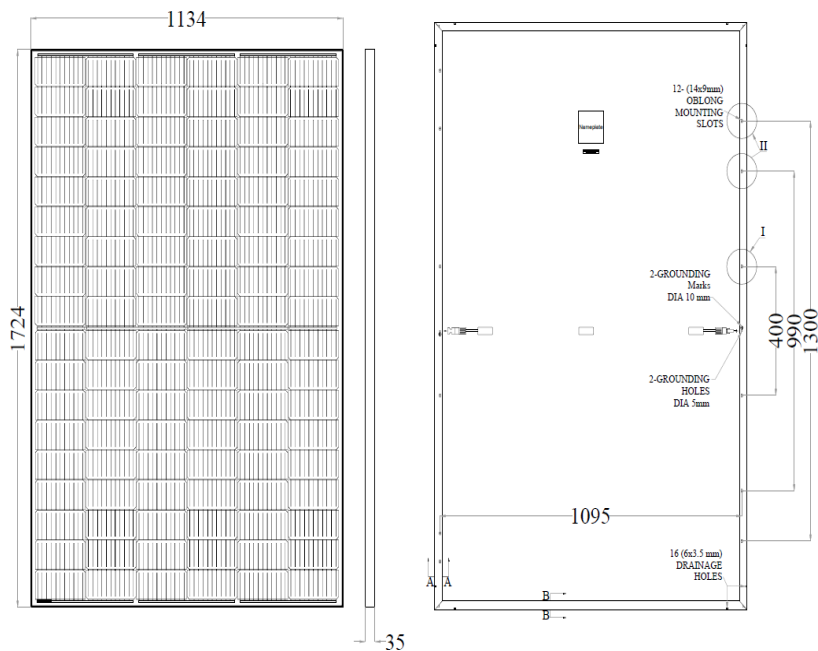

- **Model No : SGEXXX-72P (300-340 Wp) or M (340-400 Wp)**

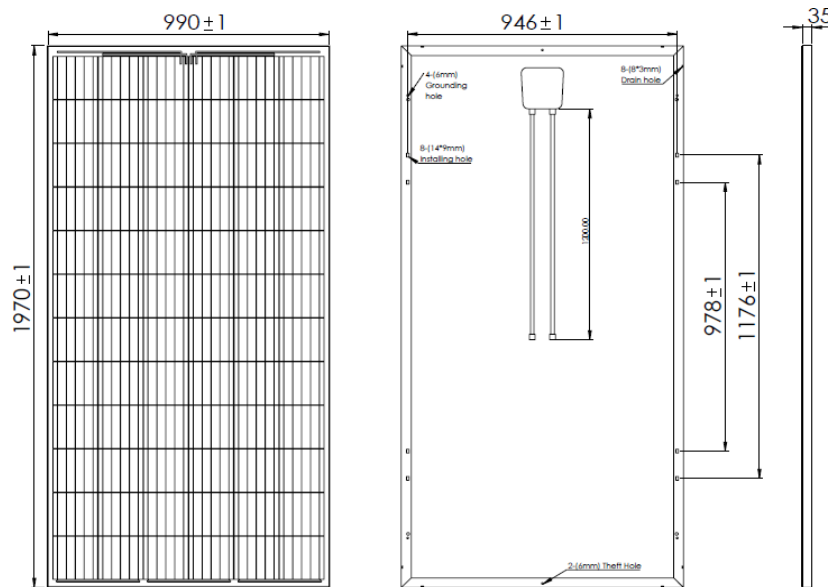

3.3.4 Technical Specification of Modules

Table 01

Models	SGEXXX-72P	SGEXXX-72M
Product Type	Multi	Mono PERC
Module Length	1970/1998	1970/1998
Module Width	990/1004	990/1004
Frame Height	35/35	35/35
Weight	22/23	22/23
Max. Voltage	1500/1500	1500/1500
Max Fuse Rating	15/15	15/15
Permissible Temp	-40 to 80C	-40 to 80C
JB Protection	IP 67	IP 67
Connector Protection	IP68	IP68
Fire Rating	Type II	Type II
Snow Load- Front	5400 Pa	5400 Pa
Wind Load- Back	2400 Pa	2400 Pa

XXX : Please refer the certificate

Table 02:



Models	SGE XXX-156MHC	SGE XXX-144MHC	SGE XXX-132MHC	SGE XXX-120MHC	SGE XXX-108MHC
Product Type	Mono PERC	Mono PERC	Mono PERC	Mono PERC	Mono PERC
Module Length	2464	2278	2096	1912	1724
Module Width	1134	1134	1134	1134	1134
Frame Height	35	35	35	35	35
Weight	31	28	25	22	20
Max. Voltage	1500	1500	1500	1500	1500
Max Fuse Rating	25	25	25	25	25
Permissible Temp	-40 to 80C	-40 to 80C	-40 to 80C	-40 to 80C	-40 to 80C
JB Protection	IP 67	IP 67	IP 67	IP 67	IP 67
Connector Protection	IP68	IP68	IP68	IP68	IP68
JB Cable length	350 mm	350 mm	350 mm	350 mm	350 mm
Fire Rating	Type II	Type II	Type II	Type II	Type II
Snow Load	5400 Pa	5400 Pa	5400 Pa	5400 Pa	5400 Pa
Wind Load	2400 Pa	2400 Pa	2400 Pa	2400 Pa	2400 Pa

3.3.5 Recommendation Mounting Method

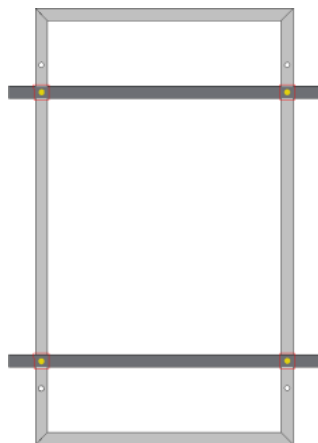

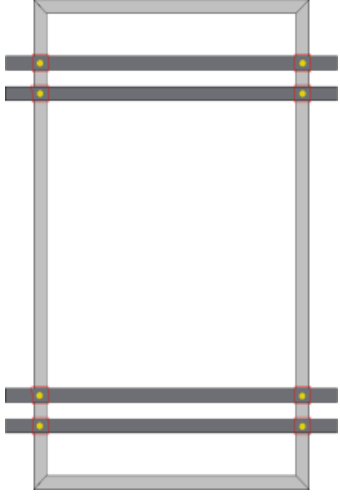
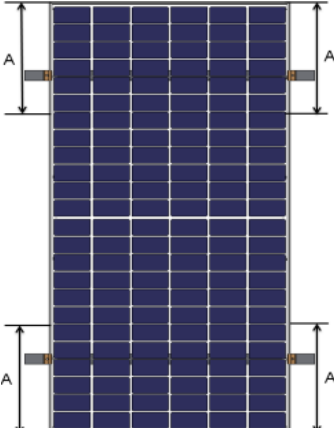
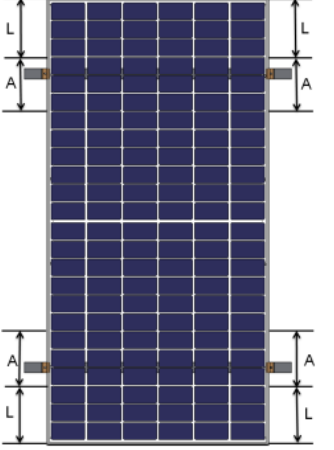
Mounting method	Mechanical load	Installation location	Applicable for Models
Four bolts mounting with beams underneath	positive 5400Pa negative 2400Pa Safety factor: 1.5		SGE XXX-156/144/132/120/108MHC & SGEXXX-72P/M/PB

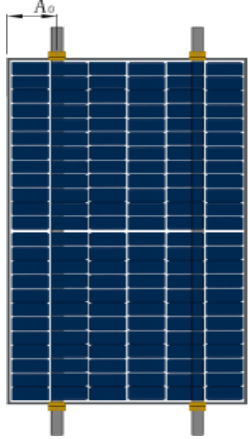
<p>Eight bolts mounting with beams underneath</p>	<p>positive 5400Pa negative 3800Pa Safety factor: 1.5</p>		<p>SGE XXX-156/144/132/120/108MHC And SGEXXX-72P/M/PB</p>
<p>Four clamps mounting with beams underneath</p>	<p>Test load: positive 2400Pa negative 2400Pa Safety factor: 1.5</p>		<p>SGE XXX-156/144/132/120/108MHC And SGEXXX-72P/M/PB</p>
<p>Four clamps mounting with beams underneath</p>	<p>positive 5400Pa negative 2400Pa Safety factor: 1.5</p>	 <p>L=400 mm, clamping zone A=250 mm</p>	<p>SGE XXX-156/144/132/120/108MHC And SGEXXX-72P/M/PB</p>
<p>Four clamps short end</p>	<p>Test load: positive 5400Pa negative 2400Pa</p>		<p>SGE XXX-156/144/132/120/108MHC And</p>

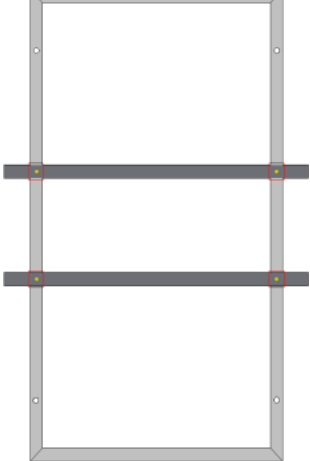
<p>mounting with beams parallel with long frame</p>	<p>Safety factor: 1.5</p>		<p>SGEXXX-72P/M/PB</p>
<p>Four clamps short end mounting with beams underneath the short frame</p>	<p>Test load: positive 2400Pa negative 2400Pa Safety factor: 1.5</p>	 <p>A0=1/4 short frame length±50mm</p>	<p>SGE XXX-156/144/132/120/108MHC And SGEXXX-72P/M/PB</p>
<p>Four bolts tracker mounting***</p>	<p>Test load: positive 1600Pa negative 1600Pa Safety factor: 1.5</p>		<p>SGE XXX-156/144/132/120/108MHC And SGEXXX-72P/M/PB</p>

Note: The module clamps must not come into contact with the front glass or deform the frame in any way. Avoid shading effects caused by clamps or insertion systems. Drainage holes in the module frame must not be closed or obscured by the clamps.

The mounting holes reserved for tracker mounting system with special accessories. If the length of module is over 2 meters, its mechanical load value for tracker needs to be confirmed by module supplier.

4.0 Electrical Installation

Module under standard testing conditions of: irradiance of 1000W /m², cell temperature of 25 °C and air mass of AM1.5. Under normal conditions, a Photovoltaic module is likely to experience conditions that produce more current and/or voltage than reported at standard test conditions. Accordingly, the values of I_{sc} and V_{oc} marked on this module should be multiplied by a factor of 1.25 when determining component voltage ratings, conductor capacities, fuse sizes, and size of controls connected to the PV output.

Voltages are additive when modules are connected in series, and modules currents are additive when Modules are connected in parallel, as illustrated in Figure 1.

Modules with different electrical characteristics must not be connected directly in series.

Series Wiring:

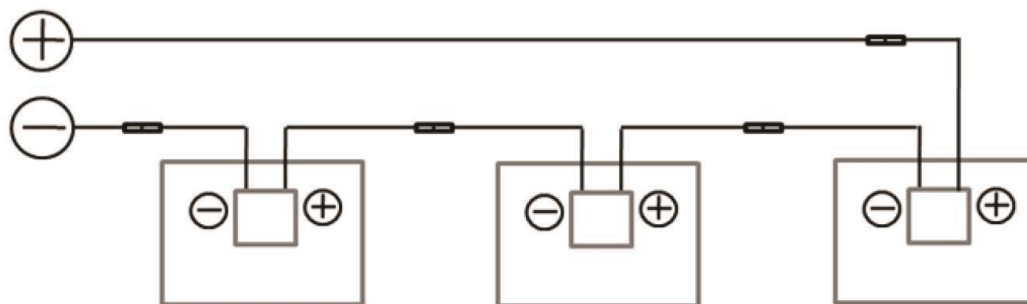

Parallel wiring

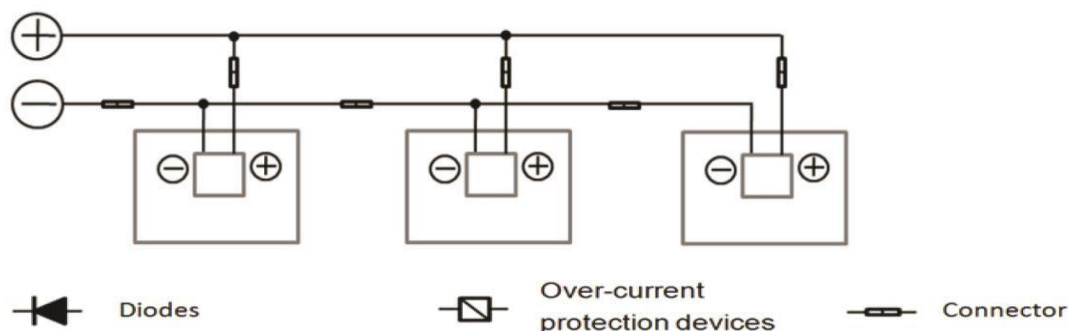

Figure 1: Electrical diagrams of series and parallel wiring.

The maximum number of Modules that can be connected in series within a string must be calculated in accordance with applicable regulations in a way that the specified maximum system voltage (The maximum system voltage of bifacial module is DC 1500V) of the modules and all other electrical DC components will not exceed in open-circuit operation at the lowest temperature expected at the PV system location.

Correction factor for the open-circuit voltage can be calculated based on the following formula:
 $CVoc=[1-\alpha(25-T)]\%$.

T is the lowest expected ambient temperature at the system location.

α (%/°C) is the temperature coefficient of the selected module Voc (Refer to corresponding datasheet).

Recommended installation method of full cell solar module:

The modules in PV array are recommended for portrait connecting, and cable length is not less than 0.7 m.

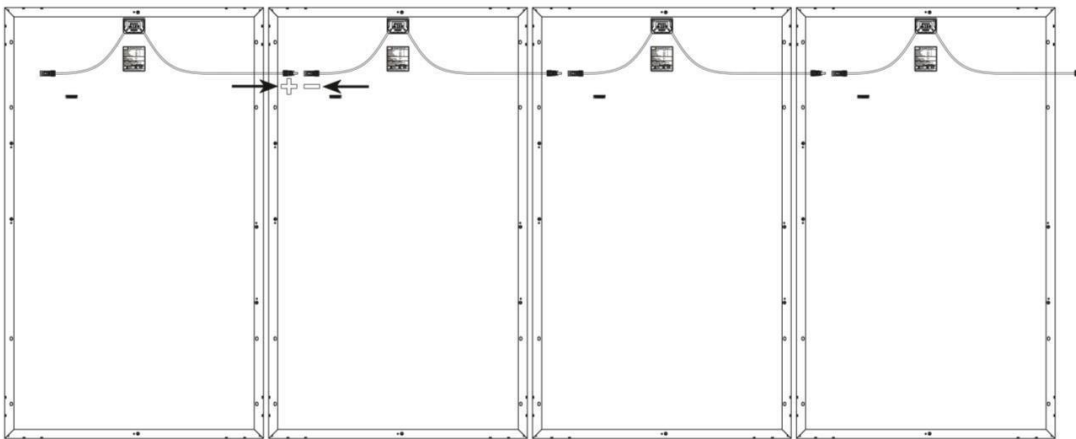

Recommended mounting method of half-cell solar module:

The head and tail of the modules in PV array are placed in a cross layout, and cable length as mentioned on Technical Datasheet sheet.

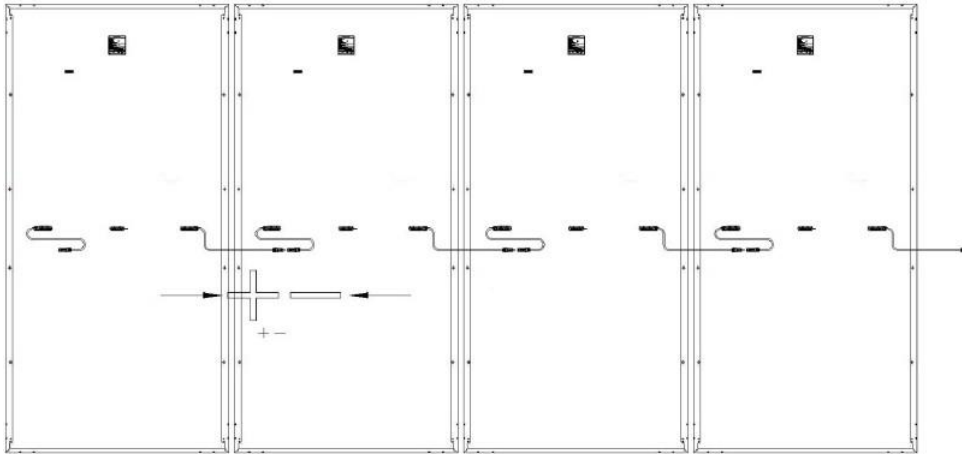

5.0 Grounding

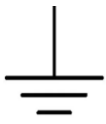

For grounding and bonding requirements, please refer to regional and national safety and electricity standards. If grounding is required, use a recommended connector type for the grounding wire.

For grounding, this guide refers to module frame grounding. If grounding is required, make sure module frames (metal exposed to touch) are always grounded.

Saatvik recommends always refer to local state and national code requirements for PV module grounding. Saatvik highly recommends negative grounding if it's allowed by local authorities.

When attaching the frame grounding hardware and wire to the frame it must be placed corresponding to the ground symbol stamped location to ensure proper electrical connection.

Saatvik recommends one of the following parts for grounding:

- 1) Use M5/M6 bolt and washer to bond the ground wire and aluminium frame through the grounding whole (as shown below). The tightening torque is 3-7Nm. All nuts and washers should be made of stainless steel. 4-14 mm² (AWG 6-12) exposed copper wire recommended as ground wire.

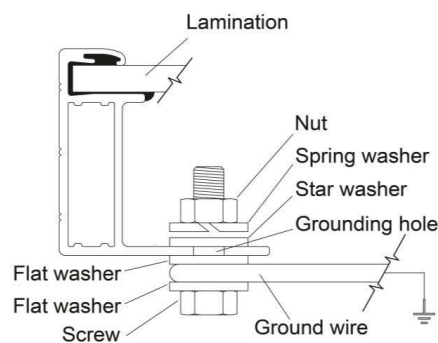

6. Important Instruction for Installation:



1. Any hardware used must be compatible with any other used material to avoid galvanic corrosion. Defects caused by corrossions void the warranty.
2. It is not recommended to use modules with different configurations (grounding, wiring) in the same system.
3. Excessive cables must be organized or fixed in an adequate way, e.g. attached to the mounting structure by using non-metallic cable ties. Solar cables, connectors and junction boxes should not be exposed to water, snow, or rain or water submersion for a long period of time (IP65/67/68).
4. For applications requiring high operating voltage several modules can be connected in series to form a string of modules; the system voltage is then equal to the sum of the voltage of each module.
5. For applications requiring high operating currents several strings of modules can be connected in parallel; the system current is then equal to the sum of the current of each string of modules.
6. The maximum system voltage is 600 volts, 1000 volts or 1500 volts depending on the product family DC according to standards. The maximum number of series connected modules depends on system design, the type of inverter used and environmental conditions.
7. Based on the maximum series fuse rating of module and local electrical installation code, always make sure Saatvik PV modules are assembled with the appropriate string fuse for circuit protection.
8. There is no specific limitation on the number of modules that can be connected in parallel, the number of modules is determined by system design parameters such as current or power output.
9. To prevent the cables and the connectors from overheating, the cross section of the cables and the capacity of the connectors must be selected to suit the maximum system short circuit current. The recommended cable is PV wire with a cross section of at least 4mm².

10. Caution: do not secure the cables too tight. Any cable damage caused by cable management system is not covered under Saatvik's warranty.
11. Always refer to the cable manufacturer's bending radius which includes the radius just behind the connectors.
12. When designing large modules arrays connected to a single inverter, always take into account the resulting isolation resistance (Riso), which decreases increasing the number of modules in the array. A too low Riso can results in inverter faults. Please refer to local regulations to determine the system wires size, type and temperature.
13. Saatvik modules are supplied with connectors used for system electrical connections. The recommended connectors are MC4 compatible.
14. Saatvik strongly recommends using the genuine connector type specified by Saatvik's product data sheet. Any choice of a different connector type other than specified may void the warranty of the module.
15. To ensure reliable electric connection and to prevent possible intrusion of humidity, two connectors must be mated and locked together until a click can be heard.
16. Long-term exposure to wet environments may cause connectors' poor connectivity, resulting in current leakage and poor conductivity which voids the warranty. Saatvik recommends proper connector/cable/wire management to prevent moisture intrusion. Depending on the amount of humidity, Saatvik recommends periodic inspections of the installation system to maintain optimal module performance.
17. The DC current generated by photovoltaic systems can be converted into AC and fed into a public Grid. As local utilities' policies on connecting renewable energy systems to the Grids vary from region to region. Always seek the advice from a qualified system designer or integrator. Building permits, inspections and approvals by the local utility are generally required.
18. Especially for larger installations Saatvik recommends lightning protection following the local requirements and regulations.
19. When the installation finished and after connecting to the grid, please do a professional hand over to the owner including an installation protocol is required. Provide a clear documentation of the system to the owner consisting of following minimum data such as: user guide, system layout, data sheets, performance expectations, and electrical system data.

7.0 Module Cleaning

Accumulated contaminants on module surface glass will reduce the power output and lead to local hot spot, such as dust, industrial wasted water and birds' droppings. The severity of influence is determined by transparency of wastes. Small amounts of dust will affect the intensity and evenness of received solar irradiation but are not dangerous and power will not be reduced remarkably generally.

- During operation of modules, there shall be no environmental factors to shade modules fully or partially. These environment factors including other modules, module mounting

system, birds dwelling, dust, soil or plants. These will significantly reduce output power. Saatvik suggests that the module surface should not be shadowed in any case.

- Frequency of cleaning depends on dirt accumulation speed. In normal situations, rainwater will clean the module surface and reduce the cleaning frequency. It is suggested to use sponge dipped with clean water or soft cloth to wipe the glass surface.
- Do not use acid and alkaline detergents to clean modules. Do not use tool with rough surface to clean in any case.
- In order to avoid potential risk of electrical shock or burn, Saatvik suggests cleaning the modules during early morning & evening with low irradiance and low modules temperature especially area with high average temperature.
- In order to avoid potential risk of electrical shock, do not try to clean the modules with glass damage or expose wires.

7.1 Method A: Compressed Water

- Requirement for water quality:
- PH: 5 ~7;
- Chloride and Salinity: 0 - 3,000 mg/L
- Turbidity: 0-30 NTU
- Conductivity: 1500~3000 $\mu\text{s}/\text{cm}$
- Total dissolved solids (TDS): ≤ 1000 mg/L
- Water hardness (calcium and magnesium ions): 0-40 mg/L
- Non-alkaline water must be used; demineralized water shall be used when conditions are available
- The maximum water pressure recommended is 4 MPa (40 bar)

7.2 Method B: Compressed Air

- We recommends using this method to clean the soft dirt (like dust) on modules. This technique can be applied as long as the method is efficient enough to clean the modules considering the on-site conditions.

7.3 Method C: Wet Cleaning

- If excessive soiling is present on the module surface, a non-conductive brush, sponge, or other mild agitating method may be used with caution.
- Please make sure that any brushes or agitating tools are constructed with non-conductive materials to minimize risk of electric shock and that they are not abrasive to the glass or the aluminium frame.
- If grease is present, an environmentally friendly cleaning agent may be used with caution.

7.4 Method D: Robot Cleaning

- If a cleaning robot is used for dry cleaning, the brush material is required to be soft plastic material, and the glass surface and aluminium alloy frame of the module will not be scratched during the cleaning process and after cleaning. The weight of the cleaning robot

should not to be too large. If the cleaning robot is improperly used, and the resulting module damage and power attenuation are not covered by Saatvik Solar's warranty.

8.0 Release and Execution

- This manual document is implemented and managed by product management department. Product management department reserves the right to modify and revise in any time.

9.0 Contact Details

Plant Address

Village Dubli, Chadiala - Kesri Road, Tehsil:, Barara, Haryana 133102

Corporate Address

Avanta Business Centre, Park Centra, 6th floor, Gurugram, Haryana 122001

Email

info@saatvikgroup.com

Phone

1800-547-1151